

Tool set for **DISASSEMBLY** compact wheel hub/bearing unit from  $\varnothing$  62 to 85 mm, **18 pcs.**



**REMOVAL:**  
FROM  $\varnothing$  62 TO  $\varnothing$  85 mm

**EFFICIENCY AND FAST USE**

**Complete Kit**

**323 046 000**

- i** ▶ This tool GOVONI set is a **PATENTED** solution for **DISASSEMBLY** modern hubs with integrated bearing type HBU2 (a pre-assembled unit combining hub and bearing, i.e. the Hub Bearing Unit) without having to disassemble the king pin/hub/bearing unit from the car and placing it on a press.
- 🔧** ▶ **DISASSEMBLY:** it can work on bearings with an external diameter from  $\varnothing$ 62 mm up to  $\varnothing$ 85 mm.
  - ▶ The tool set's modularity consists in its innovative removal semirings **1** the diameter of which can be changed by means of intermediate spacers **2** so as to adapt to the diameter of the bearing to be removed.

- 👉** ▶ The main advantages are:
  - **UNIVERSAL disassembling system** (suitable to all the models).
  - **Use directly on the vehicle.**
  - **Safety use** in assembling/disassembling (no breakage or damage of the hub).
  - **It reduces working time of 25%** compared to common tools.

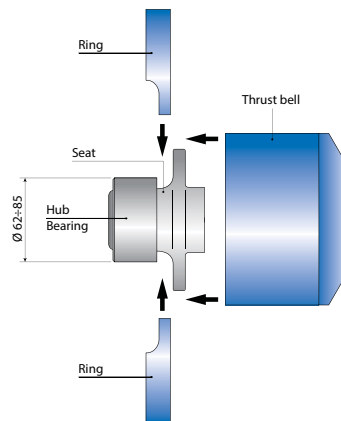
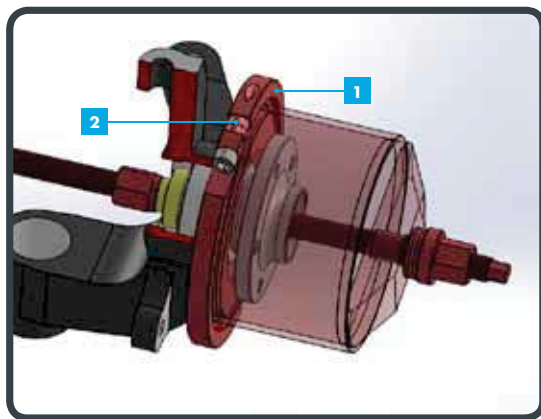

BEARINGS	BRAND
$\varnothing$ 62	Audi, VW
$\varnothing$ 66	Skoda
$\varnothing$ 68	Citroën, Renault
$\varnothing$ 72	Audi, Seat
$\varnothing$ 75	Mitsubishi, Smart
$\varnothing$ 78	Ford, Volvo
$\varnothing$ 82	Ford, Volvo
$\varnothing$ 85	4x4, SUV

**UPGRADE OPTION**

**270 025 000**  
Hydraulic cilinder  
17 TON



**271 004 000**  
Hydraulic hand pump  
700 Bar



**GO OPERATING DIRECTLY ONTO THE VEHICLES**

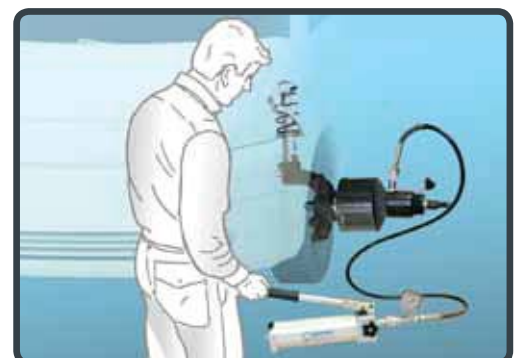

## Kit for hubs/bearings

### Components

THRUST BELL

**323029001**

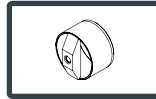

M20x1.5 SPINDLE -  
HEX. 1.5 mm

**323029004**



COUNTERTHRUST NUT  
(2 PCS.)

**323029012**

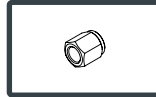

HEX. 30 mm THRUST BLOCK  
BEARING

**323029015**

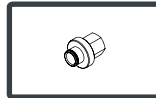

PULLING BUSH Ø72, Ø75,  
Ø78, Ø82, Ø85 mm

**323029022**



### Components

PULLING BUSH Ø62, Ø66,  
Ø68 mm

**323034010**



PULLING RING

**323029010**



SPACERS Ø18x9 FOR PULLING  
RING (4 PCS.)

**323029021**



SPACERS Ø18x3 (4 PCS.)

**323029014**







SCREW 12x55 (2 PCS.)

**822084000**



### ON DEMAND

#### INSTALLATION BEARINGS

<b>323034004</b>	<b>Ø 62</b>	Audi, VW	
<b>323034003</b>	<b>Ø 66</b>	Skoda	
	<b>Ø 68</b>	Citroën, Renault	
<b>323029016</b>	<b>Ø 72</b>	Audi, Seat	
	<b>Ø 75</b>	Mitsubishi, Smart	
	<b>Ø 78</b>	Ford, Volvo	
<b>323029006</b>	<b>Ø 82</b>	Ford, Volvo	
	<b>Ø 85</b>	4x4, SUV	